

# ProfileSolutions

LEAK DETECTION + AUTOMATION TECHNOLOGY

## ALUMINIUM PROFILE & ACCESSORIES

Our aluminium profiles are manufactured using high grade A6N01S-T5 aluminium and provided with longitudinal slots used to house nuts and specialised connection systems enabling easy but strong connections with adjacent profiles, brackets or anything else.

Used for machine structural frames, conveyors, workbenches, shelving systems etc. The possibilities are endless, limited only to your imagination.

This catalogue exhibits the basic range of profile and accessories. For further information and detailed specifications please contact Profile Solutions.

**LOW COST CONNECTING  
TECHNOLOGY FOR OUR  
PROFILE AND MANY OTHER  
SYSTEMS.**

- Cast Brackets
- Steel brackets
- Plates
- Nuts m3-m8 that fits many T-slot brands.

**Tight radius external corners  
on T- slot profiles for a  
superior finished product**

# OUR PROFILE RANGE



SP2020



SP3090



SP4080



LP6060



LP4040



RP2020



SP30120



SP40120



LP6090



LP4080



SP2040



SP6060



SP40160



GR4023

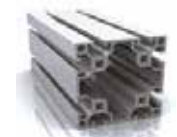

LP8080



SP1530



RP6060



SP8080



SP3060



GR4055



SP3030



SP6090



SP80120



LP30120



LP3090



RP3030



SP4040



LP3030



SP4040-1



GR3045



SP3030-1



RP4040



LP3060



Nuts, Bolts & Washers



Feet & Castors



Aluminium brackets



Steel brackets



Steel Joiners







Hinges



Handles

# PROFILE SECTION DATA & PRICING

Profile	Profile P/N	Profile Type	X	Y	Slot Type	Weight kg/m	2 <sup>nd</sup> Area Moment		Area Cross Section	Price/m (6m lengths)	End Cap Part Number	Price each
			mm	mm			I <sub>x</sub>	I <sub>y</sub>				
Type 20	SP2020	Square section	20	20		0.39	0.59	0.59	145.94	\$12.50	SC2020	\$0.41
	RP2020	Curved corner profile	20	20		0.36	0.34	0.55	131.42	\$10.50	SCR2020	\$1.50
	SP2040	Rectangle section	20	40		0.74	0.59	4.20	273.50	\$19.60	SC2040	\$0.60
Type 30	SP1530	Rectangle section	15	30		0.76	0.70	1.50	246.30	\$14.63	SC1530	\$0.85
	SP3030	Square section	30	30		1.07	3.60	3.60	395.50	\$23.70	SC3030	\$0.60
	RP3030	Curved corner profile	30	30		0.94	1.90	3.50	345.50	\$22.40	SCR3030	\$1.64
	SP3030-1	Square profile – 1 closed side	30	30		1.10	3.83	3.59	405.70	\$25.20		
	GR3045	Sliding door guide – 2 channel	30	45		1.63	10.20	5.80	601.60	\$38.50		
	SP3060	Rectangle section	30	60		1.80	6.50	6.50	644.00	\$39.06	SC3060	\$0.75
	SP3090	Rectangle section	30	90		2.54	9.50	76.20	938.20	\$57.40	SC3090	\$0.90
	SP30120	Rectangle section	30	120		3.27	12.40	169.70	1209.80	\$74.20	SC30120	\$1.10
	SP6060	Square section	60	60		2.72	42.30	42.30	1004.00	\$64.40	SC6060	\$1.35
	RP6060	Curved corner profile	60	60		2.56	22.44	41.80	935.97	\$58.80	SCR6060	\$2.80
	SP6090	Rectangle section	60	90		3.60	618.00	128.80	1326.00	\$81.20	SC6090	\$1.65
Type 40	SP4040	Square section	40	40		1.93	11.40	11.40	712.60	\$40.46	SC4040	\$0.80
	RP4040	Curved corner profile	40	40		1.71	6.30	11.90	629.50	\$41.30	SCR4040	\$2.10
	SP4040-1	Square profile – 1 closed side	40	40		1.95	11.40	12.00	720.40	\$45.50		
	GR4055	Sliding door guide – 3 channel	40	55		2.42	14.80	23.20	819.40	\$54.60		
	SP4080	Rectangle section	40	80		3.39	22.50	79.10	1251.80	\$75.60	SC4080	\$1.35
	SP40120	Rectangle section	40	120		4.55	29.80	242.40	1680.20	\$105.00	SC40120	\$3.20
	SP40160	Rectangle section	40	160		5.83	38.90	536.60	2150.00	\$147.00	SC40160	\$3.90
	SP8080	Square section	80	80		5.24	144.10	144.10	1933.00	\$119.00	SC8080	\$2.47
	SP80120	Rectangle section	80	120		6.87	192.20	396.60	2534.40	\$161.00	SC80120	\$3.60
Type 30 (Light Duty)	LP3030	Square section	30	30		0.85	3.02	3.02	313.60	\$19.53	LC3030	\$0.60
	LP3060	Rectangle section	30	60		1.45	5.50	20.18	535.34	\$33.46	LC3060	\$0.75
	LP3090	Rectangle section	30	90		2.05	7.99	61.45	757.31	\$56.00	LC3090	\$0.90
	LP30120	Rectangle section	30	120		2.65	10.48	136.77	978.82	\$67.20	LC30120	\$1.10
	LP6060	Square section	60	60		2.23	34.89	34.89	821.45	\$50.68	LC6060	\$1.35
	LP6090	Rectangle section	60	90		3.00	49.58	101.23	1107.23	\$74.20	LC6090	\$1.65
Type 40 (Light Duty)	LP4040	Square section	40	40		1.68	10.00	10.00	621.00	\$35.00	LC4040	\$0.80
	GR4023	Sliding door guide – 3 channel	40	23		1.39	1.90	9.30	513.40	\$33.60		
	LP4080	Rectangle section	40	80		2.72	17.20	58.40	1005.00	\$64.40	LC4080	\$1.35
	LP8080	Square section	80	80		4.36	118.30	118.30	1607.60	\$102.20	LC8080	\$2.47

Standard length: 6 meters  
 Cutting charge: \$2.50 per cut  
 Drilling charge: \$2.00 per hole (straight or counterbore)  
 Tapping charge: \$2.50 per profile end

## Profile and Slot Detail

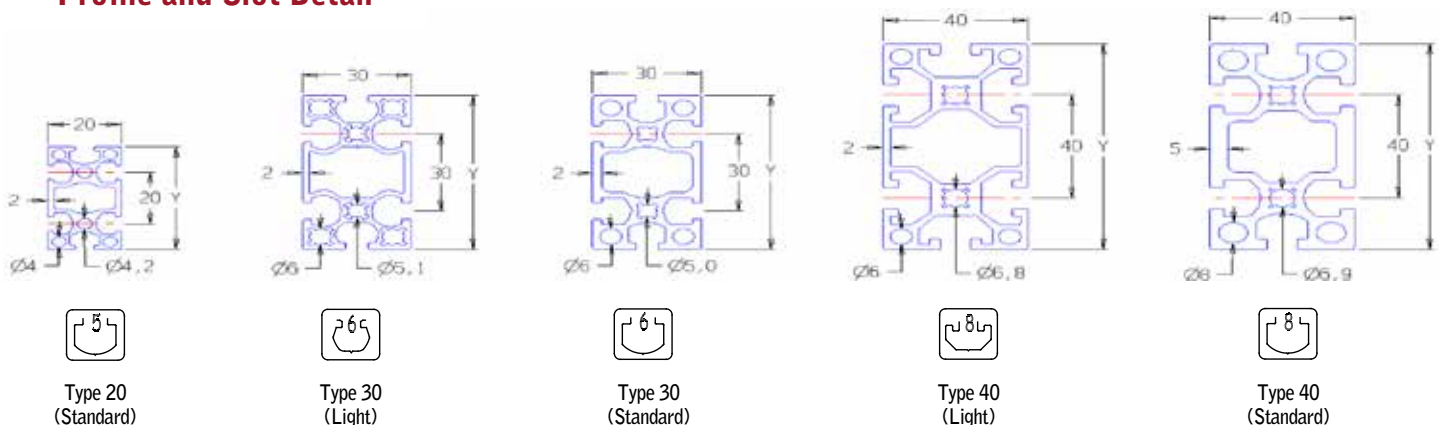

# PROFILE DEFLECTION UNDERLOAD DATA

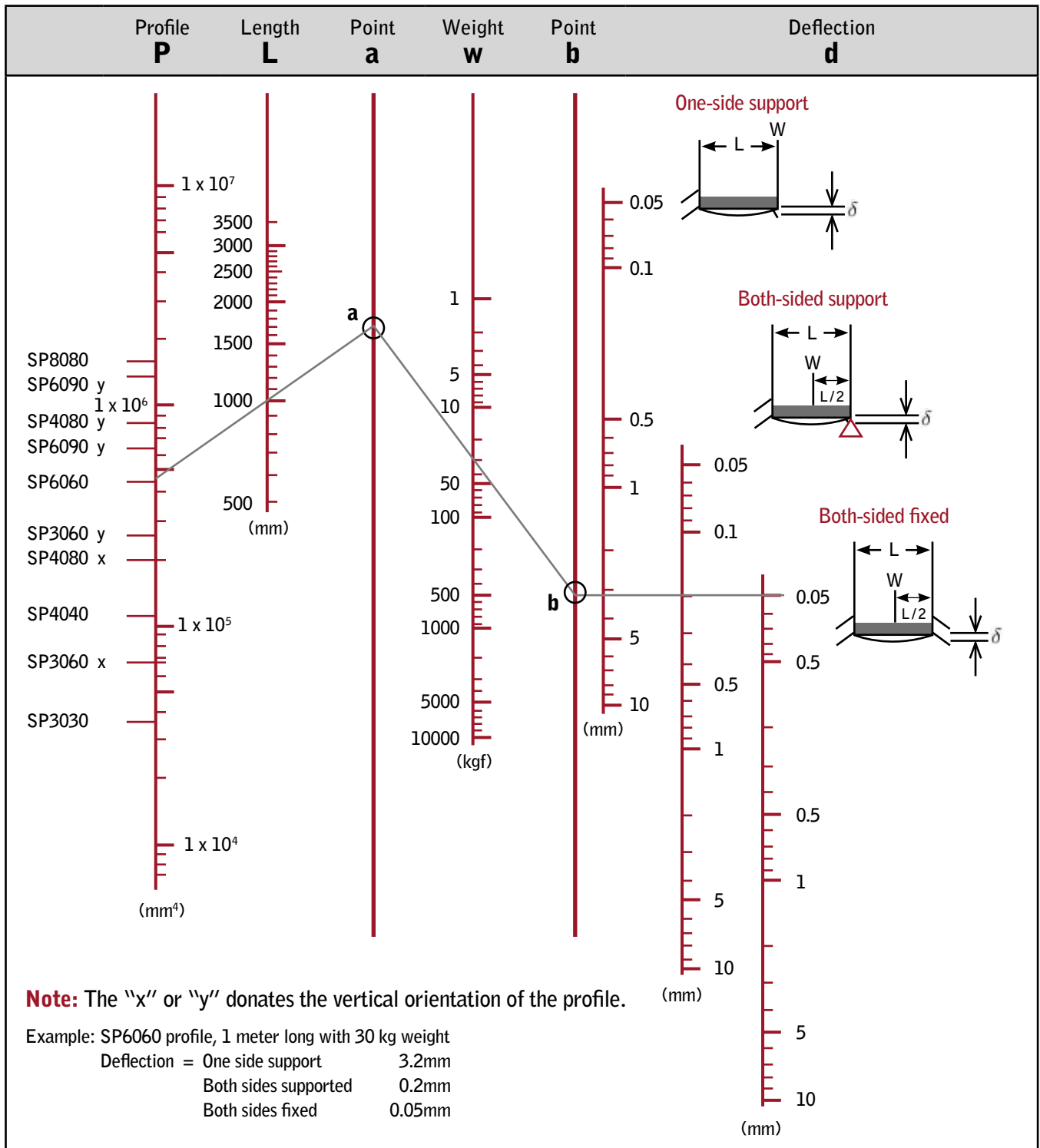

## Method:

1. Obtain **P** and **L** values and project a line to get point "a" on the graph.
2. Obtain **W** and project a line from point "a" to get point "b" on the graph.
3. Extend the line horizontally to the corresponding support method.
4. Read the value which is the amount of deflection the beam with exhibit.

# PROFILE ACCESSORIES

	<b>Inner Bracket</b>	DIB2020 DIB3030 DIB4040	20 30 40	25x25x10 40x40x10 60x60x13	\$1.40 \$1.60 \$3.00
	<b>Joint Clip</b>	DJC20-5 DJC30-6 DJC40-8	20 30 40	19x8x5 – M5 28x10x8 – M6 38x14x11 – M8	\$0.35 \$0.45 \$0.50
	<b>Hinges</b>	WZ-2020HY WZ-3030HY WZ-4040HY All metal hinges	20 30 40	30x40 45x52.5 50x60	\$6.90 \$7.90 \$8.90
	<b>Handles</b>	WZ-ZBS-M8 WZ-ZBS-M0	30/40 30/40	139x26 – M8 Female 139x26 – Suit M6 bolt	\$4.50 \$4.50
	<b>Angle Joint</b>	DAJ-06 DAJ-08	30 40	Precision cast zinc Precision cast zinc	\$19.00 \$19.00
	<b>Slot Cover</b>	PE-20 PE-30 PE-40 PE-50	20 30 40 50	Slot cover – Polyethylene Slot cover – Polyethylene Slot cover – Polyethylene Slot cover – Polyethylene	\$2.63 \$2.63 \$2.75 \$7.00
	<b>Socket Head Cap Screw</b>	SHCSM6X16ZP SHCSM6X20ZP SHCSM8X12ZP SHCSM8X16ZP SHCSM8X20ZP	M6x16 long, zinc plated M6x20 long, zinc plated M8x12 long, zinc plated M8x16 long, zinc plated M8x20 long, zinc plated	\$0.15 \$0.25 \$0.18 \$0.19 \$0.20	
	<b>Button Head</b>	BSHCSM5X16ZP BSHCSM6X16ZP BSHCSM6X20ZP BSHCSM8X16ZP BSHCSM8X20ZP	M5x16 long, zinc plated M6x16 long, zinc plated M6x20 long, zinc plated M8x16 long, zinc plated M8x20 long, zinc plated	\$0.20 \$0.26 \$0.29 \$0.37 \$0.37	
	<b>Washer</b>	WM6X12SZP WM6X20SZP WM8X16SZP WM8X22SZP	Flat washer M6x12 OD, zinc plated Flat washer M6x20 OD, zinc plated Flat washer M8x16 OD, zinc plated Flat washer M8x22 OD, zinc plated	\$0.02 \$0.03 \$0.04 \$0.05	
	<b>Foot Base</b>	FB3060 FB3090 FB4080 FB40120 FB6060 FB8080	Suit Profile PS3060 – M12 Suit Profile PS3090 – M12 Suit Profile PS4080 – M12 Suit Profile PS40120 – M12 Suit Profile PS6060 – M12 Suit Profile PS8080 – M12	\$7.40 \$9.80 \$9.85 \$11.50 \$9.85 \$14.00	
	<b>Adjustable Foot</b>	GJX60-0880 GJX60-10100 GJX60-12100 GJ60-16100 GJ60-20100	600kg 600kg 600kg 1000kg 1000kg	60mm Base, M8x80 high 60mm Base, M10x100 high 60mm Base, M12x100 high 60mm Base, M16x100 high 60mm Base, M20x100 high	\$8.25 \$9.25 \$12.75 \$15.20 \$17.30
	<b>Swivel Castor - German made</b>	PS75 - plate PS75 - D12 PS75 - with brake PS100-plate PS100-D12 PS100-D12 brake Other size available	75kg 55 kg 55 kg 100kg 100kg 80kg	75 mm Wheel plate 75 mm Wheel D10 75 mm Wheel d10 brake 100 mm Wheel plate 100 mm Wheel D12 100 mm Wheel D12 brake	\$27.00 \$27.00 \$33.00 \$31.00 \$31.00 \$37.00
	<b>Rod Flange Bracket</b>	HS P104-12 \$9.00 Hole12 mm, heavy duty 70x30x90. Smaller size available. HS P102-12 \$5.00			
	<b>Rod Bracket + many othe sizes &amp; types</b>	HS-P103-12 \$6.00 Hole 12mm, heavy duty 30x74x30.			
	<b>Rod Sensor Bracket</b>	HS-P105-12 \$8.00 21 58x30x20 Hole 19mm			
	<b>Guide Rail Bracket with Knob + Rotating head types</b>	12 mm rod Small HS-P201-12 \$9.90 Medium HS P203-12 \$17.50 Large HS P204-12 \$18.80			
	<b>Guide Rod</b>	12x150			\$4.50

Accessory	Part Number	Slot/Profile	Description	Price Each
	DBS-20M4		M4 nut 8x8x2	\$0.18
	DBS-20M5		M5 nut 8x8x2	\$0.18
	DBS-20M6		M6 nut 8x8x3	\$0.18
	DBS-30M4		M4 nut 10x10x5	\$0.18
	DBS-30M5		M5 nut 10x10x5	\$0.18
	DBS-30M6		M6 nut 10x10x5	\$0.18
	DBS-40M6		M6 nut 14x14x6	\$0.20
	DBS-40M8		M8 nut 14x14x6	\$0.20
	DBSQ-30M6		M6 nut 10x12x5	\$0.20
	DBSQ-40M6-1416		M6 nut 14x16x6.5	\$0.35
	DBSQ-40M8-1416		M8 nut 14x14x6.5	\$0.35
	DBSQ-40M8-1220		M8 nut 12x20x6.5	\$0.40
	DSN-20M3		Spring nut M3	\$0.70
	DSN-20M4		Spring nut M4	\$0.70
	DSN-20M5		Spring nut M5	\$0.70
	DSN-30M4		Spring nut M4	\$0.70
	DSN-30M5		Spring nut M5	\$0.70
	DSN-30M6		Spring nut M6	\$0.70
	DSN-40M4		Spring nut M4	\$0.80
	DSN-40M5		Spring nut M5	\$0.80
	DSN-40M6		Spring nut M6	\$0.80
	DSN-40M8		Spring nut M8	\$0.80
	DTN-20M3		T slot nut M3	\$0.70
	DTN-20M4		T slot nut M4	\$0.70
	DTN-30M3		T slot nut M3	\$0.60
	DTN-30M4		T slot nut M4	\$0.60
	DTN-30M5		T slot nut M5	\$0.60
	DTN-30M6		T slot nut M6	\$0.60
	DTN-40M3		T slot nut M3	\$0.60
	DTN-40M4		T slot nut M4	\$0.60
	DTN-40M5		T slot nut M5	\$0.60
	DTN-40M6		T slot nut M6	\$0.60
	DLN-20M5		M6 Long nut 80x8x5	\$1.15
	DLN-30M6		M8 Long nut 110x10x6	\$2.60
	DLN-40M8	M8 Long nut 110x14x8	\$3.30	
	DSB8080-6	30	80x80	\$3.40
	DSB105105-8	40	105x105x35	\$5.50
	DSB2585-6	30	80x80x25	\$2.20
	DSB75105-8	40	110x75x35	\$5.80
	DSB2555-6	30	25x55	\$1.95
	DSB3575-8	40	35x75	\$2.60
	DCB2025-6	20	25x25x18 wide	\$1.20
	DCB3025-6	30	30x30x25 wide	\$1.40
	DCB3055-6	30	30x30x55 wide	\$3.10
	DCB5560-6	30	55x55x60 wide	\$4.50
	DCB4035-8	40	40x40x35 wide	\$2.05
	DCB4075-8	40	40x40x75 wide	\$4.45
	DCB7575-8	40	75x75x75 wide	\$7.50
	DSB2015-6	20	20x20x15 wide	\$1.37
	DSB2035-6	20	20x20x35 wide	\$1.82
	DSB3025-6	30	30x30x25 wide	\$1.70
	DSB3055-6	30	30x30x55 wide	\$2.34
	DSB6055-6	30	60x60x55 wide	\$4.62
	DSB4035-8	40	40x40x35 wide	\$1.95
	DSB4075-8	40	40x40x75 wide	\$3.77
	DSB8075-8	40	80x80x75 wide	\$6.48



# WORK BENCHES & TROLLEYS MADE TO ORDER

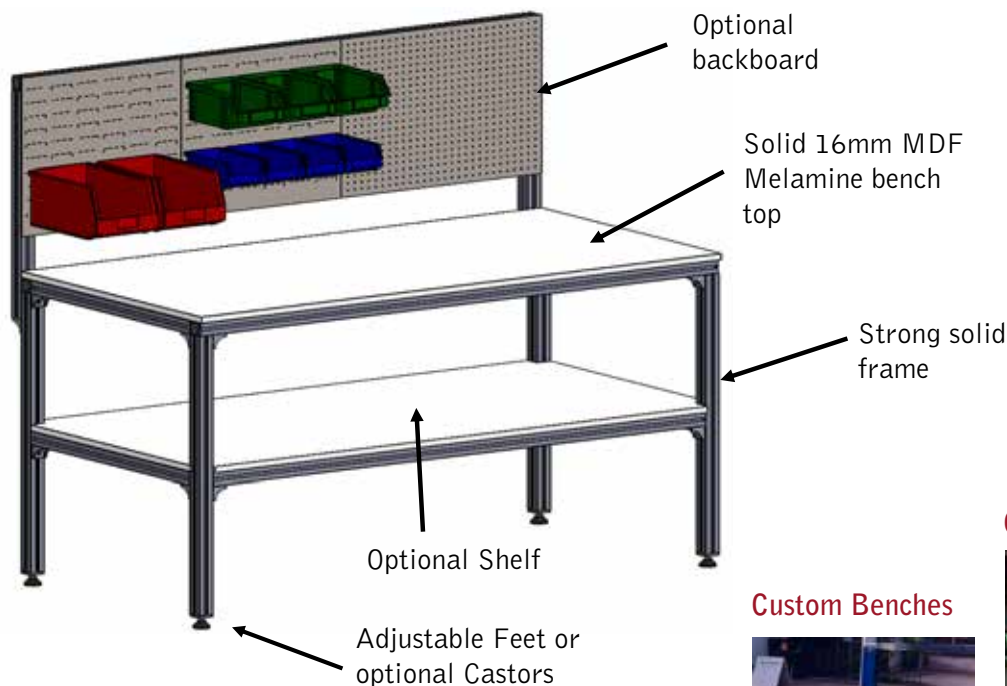

Custom sizes - Plus we can add drawers, too hangars, lights, different tabletops, ducting and cable management, foot rests, work lights, power-points and more ....

## Trolleys



## Trolley Parts Custom design



## Industrial White Board



## Custom Benches



Work Bench Sizes - Standard and Custom				
Size	Length	Depth	Height	Price
Small	1200	800	900	\$648
Medium	1600	800	900	\$783
Large	1800	800	900	\$1,089

Note: Custom sizes available

Work Station – Electrical Height Adjustable (140kg)				
Size	Length	Depth	Height	Price
Small	1200	800	680–1200	\$1,699
Medium	1600	800	680–1200	\$1,764
Large	1800	800	680–1200	\$2,350

Note: Dual actuator system. We can also supply single actuators as well

Options for Work Benches		
Shelf	Backboard	Castors
Small \$160	\$450	\$199
Med \$180	\$490	\$199
Large \$210	\$520	\$199

Note: Peg and louver panel extra



Electric Height Adjustment

# Mitchell Industries & ProfileSolutions

Profile Solutions, Mitchell Industries & Profile Automation are trading names of Gecam Industries Pty Ltd ABN 69 059 194 071



68 Lancaster Drive Goonellabah NSW 2158 •

Phone: 1300 554 599, • Mobile: 0417 339 571 (Factory)

Email: sales@profauto.com.au (Australia & NZ) •

Website: www.profileautomation.com.au • www.profauto.com.au • www.mitchellindustries.com